



MP Antenna, LTD.
147 Eady Court
Elyria, Ohio 44035

440.387.5968 phone
440.545.3500 fax
www.mpantenna.com
sales@mpantenna.com

Model: Dual Feed Outdoor Mobile MIMO Antenna

item part number: 08-ANT-1020
product description: 700MHz- 3GHz Dual SMA Male Connectors

Electrical Data

frequency range:	700MHz- 3GHz	environmental cond.:	Outdoor/Indoor
gain:	6dBi *	operation temperature:	-40 to 85 deg C
vswr:	<2:1	storage temperature:	-40 to 85 deg C
horizontal pattern type:	Omni Directional	transport temperature:	-40 to 85 deg C
vertical patter type:	Hemispheric	IP Rating:	IP67
ground plane:	Built In	RoHS - REACH	Compliant
min ground plane:	N/A		

Environmental Data

General Data

color:	Black	length:	6.10 in
antenna feeds:	Two	width:	6.10 in
coax length:	N/A	height:	4.10 in
coax type:	N/A	total height:	See Drawing
connector type:	Various	mounting type:	Thru Hole
polarization:	Multi-Polarized	hardware included:	Nuts, Washer
power:	50 Watts Input		
impedance:	50 ohms Nominal		
construction:	UV Stabilized Polymers		

Mechanical Data

*** With built in spatial and polarization diversity, performance in obstructed environments is greater than that of standard antennas with similar or higher laboratory gains.**



FREQUENCY RANGE	CONNECTOR	MINIMUM MOUNTING HOLE DIAMETER	MAX MOUNTING HOLE DIAMETER	MAX MOUNTING SURFACE THICKNESS	COLOR	NUMBER OF FEEDS
700-2700 MHz	SMA MALE	0.76 INCHES	1.25 INCHES	0.75 INCHES	BLACK	2

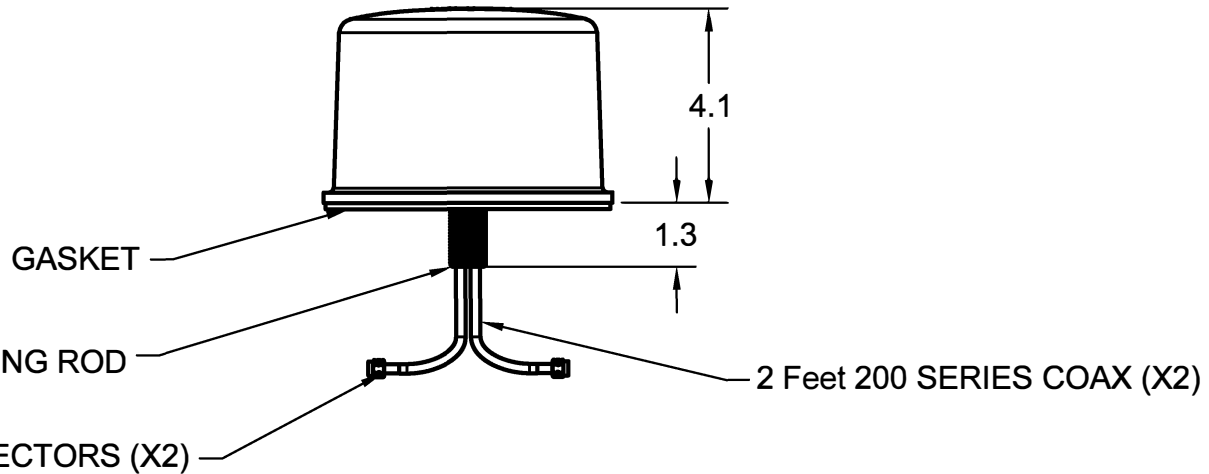
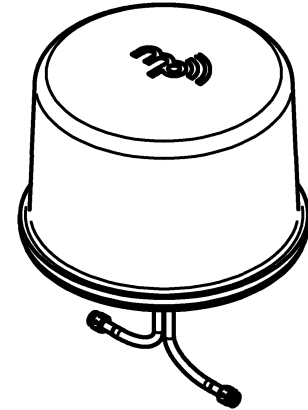
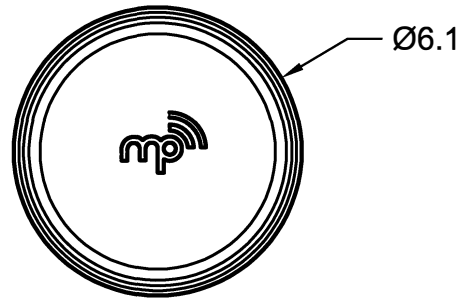

NOTE: MOUNTING CUT NUT AND CUT WASHER INCLUDED

MP ANTENNA, LTD. 147 Eady Court Elyria, Ohio 44035 www.mpantenna.com	THIRD ANGLE DIMENSIONS ARE IN INCHES	PROPRIETARY AND CONFIDENTIAL THE INFORMATION CONTAINED IN THIS DRAWING IS THE SOLE PROPERTY OF MP ANTENNA, LTD. ANY REPRODUCTION IN PART OR AS A WHOLE WITHOUT THE WRITTEN PERMISSION OF MP ANTENNA LTD IS PROHIBITED.	DESCRIPTION: 700-2700 MHz 2X MIMO ANTENNA	PART NO. 08-ANT-1020-BL-2X-B2				
	<table border="1"> <tr> <td>NAME</td> <td>DATE</td> </tr> <tr> <td>BM</td> <td>3/10/23</td> </tr> </table>				NAME	DATE	BM	3/10/23
	NAME				DATE			
BM	3/10/23							
DRAWN								



MP Antenna, LTD.
147 Eady Court
Elyria, Ohio 44035

440.387.5968 phone
440.545.3500 fax
www.mpantenna.com
sales@mpantenna.com

Model: Dual Feed Outdoor Mobile MIMO Antenna

Item part number: 08-ANT-1020
product description: 700MHz- 3GHz Dual SMA Male Connectors

Frequency: 700-900 MHz
Max Gain: 6dBi

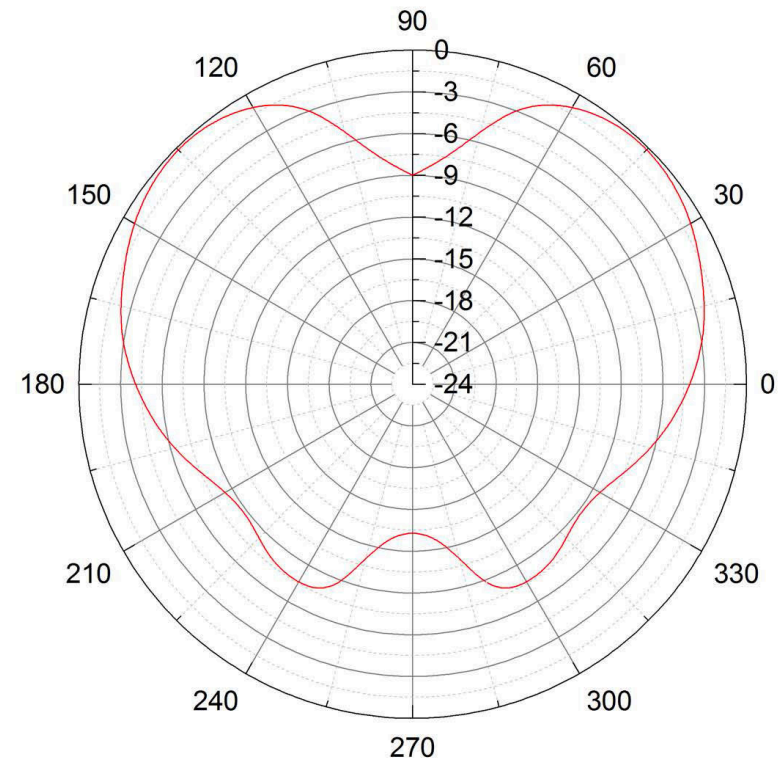
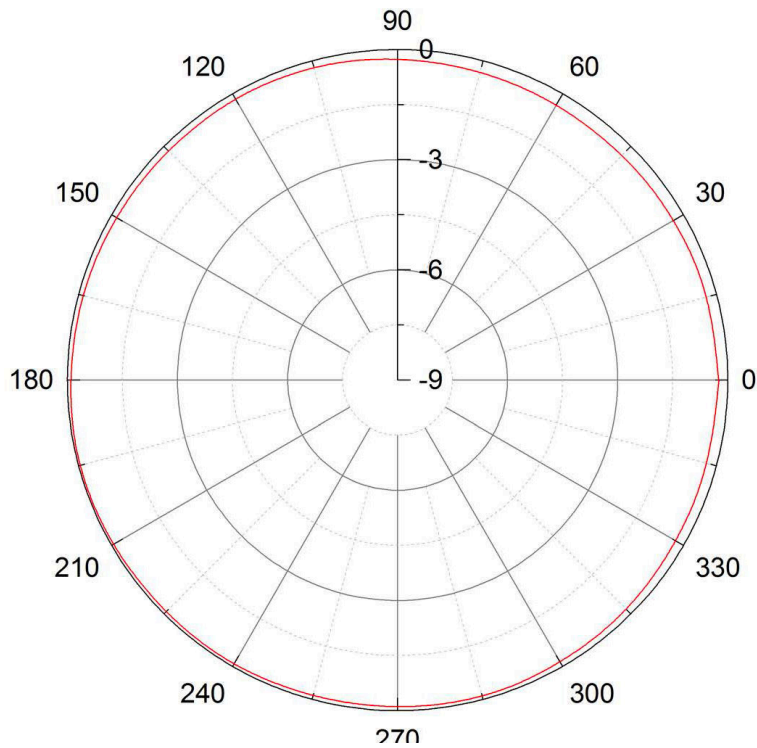



MP Antenna, LTD.
147 Eady Court
Elyria, Ohio 44035

440.387.5968 phone
440.545.3500 fax
www.mpantenna.com
sales@mpantenna.com

Model: Dual Feed Outdoor Mobile MIMO Antenna

item part number: 08-ANT-1020
product description: 700MHz- 3GHz Dual SMA Male Connectors

Frequency: 800-2100 MHz
Max Gain: 6dBi

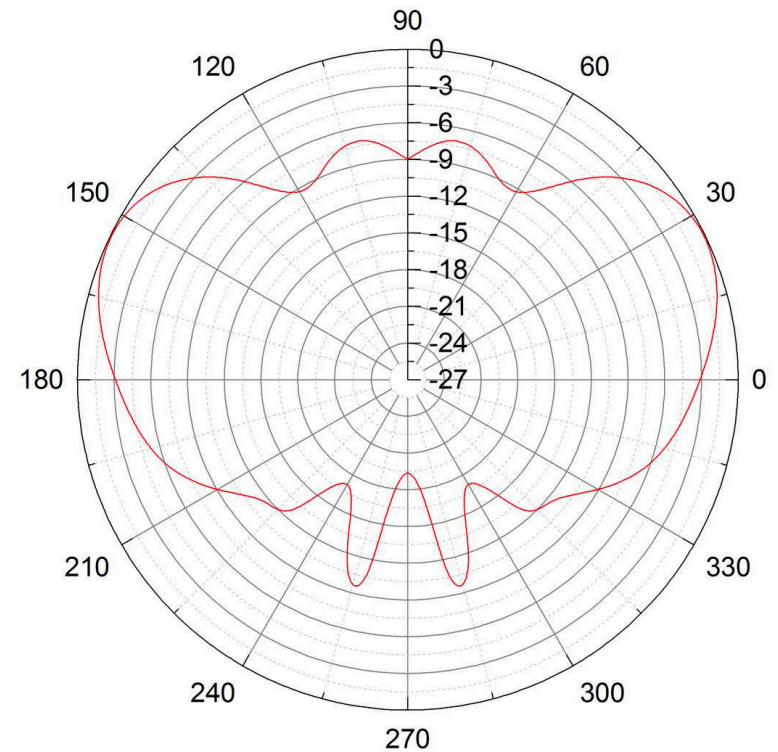
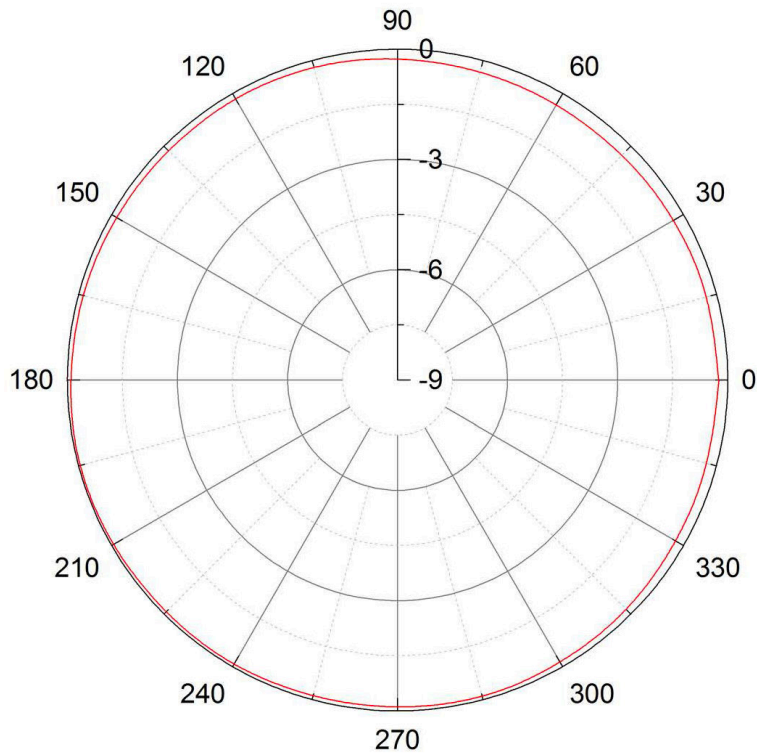



MP Antenna, LTD.
147 Eady Court
Elyria, Ohio 44035

440.387.5968 phone
440.545.3500 fax
www.mpantenna.com
sales@mpantenna.com

Model: Dual Feed Outdoor Mobile MIMO Antenna

item part number: 08-ANT-1020
product description: 700MHz- 3GHz Dual SMA Male Connectors

Frequency: 2300-2600 MHz
Max Gain: 6dBi

